

15 mm keychain sewn like a lanyard

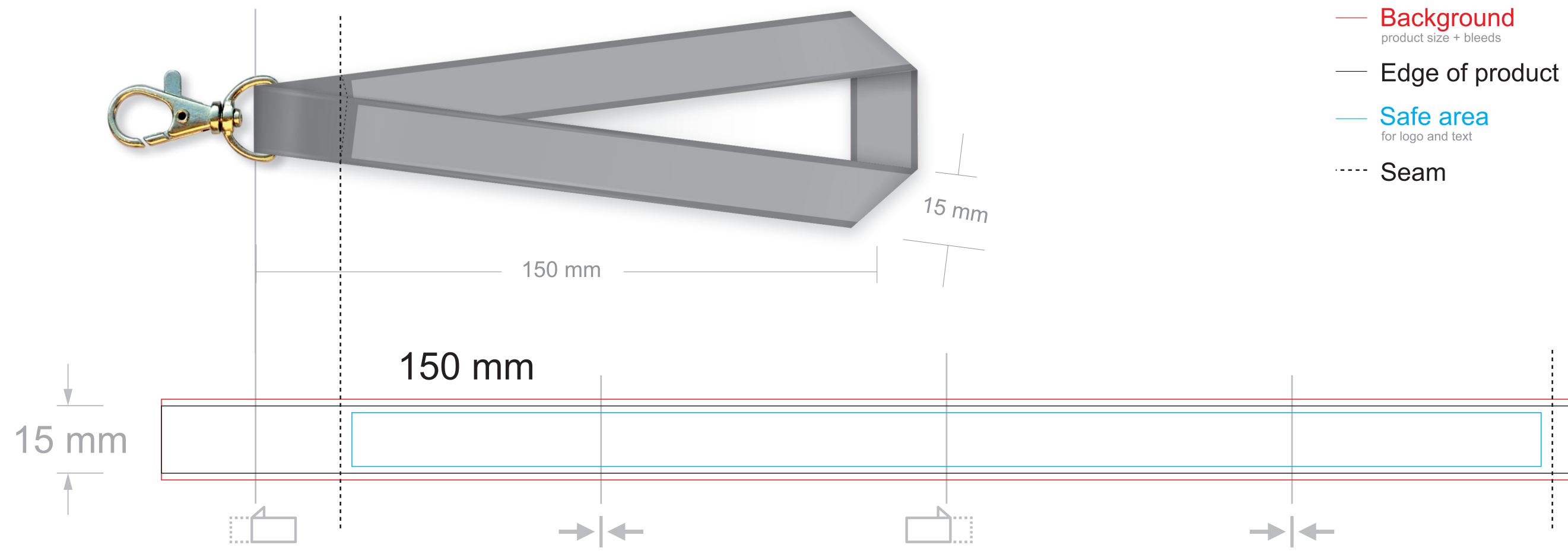

Choose the length of the finished keychain.

